

Stepper MOTOR

57SH41-M High Torque Hybrid

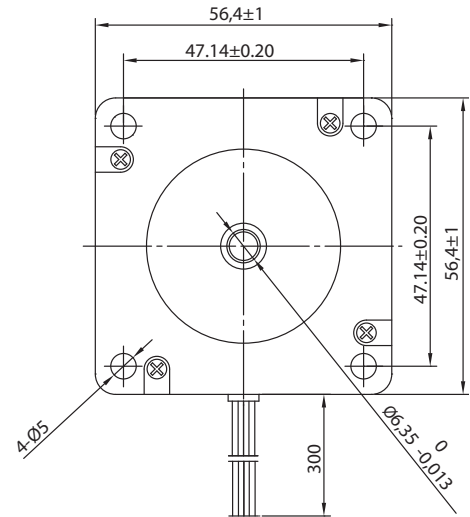
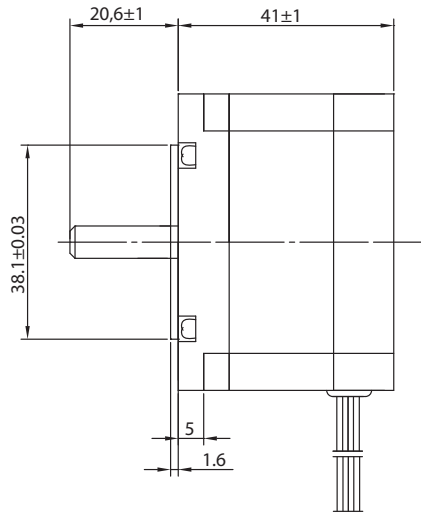
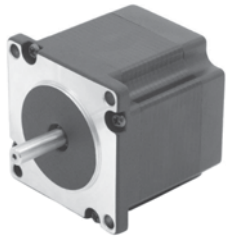

BE version: rear shaft 13mm- 2x M2.5 on diam. 46 mm

Characteristics

STEP ANGLE
0,9°

STEP ANGLE ACCURACY
± 5%

INSULATION CLASS
B

AMBIENT TEMPERATURE
-20°C +50°C

TEMP. RISE
80°C MAX (RATED CURRENT, 2 PHASE ON)

INSULATION RESISTANCE
100 M OHM MIN. 500 VDC

DIELECTRIC STRENGTH
500 VAC FOR ONE MINUTE

SHAFT RADIAL PLAY
0,02 MAX (450 G LOAD)

SHAFT AXIAL PLAY
0,08 MAX. (450 G LOAD)

MAX RADIAL FORCE
75 N (20 MM FROM FRONT FLANGE)

MAX AXIAL FORCE
15 N

Specification

Model		57SH41-1AM	57SH41-2AM	57SH41-3AM	57SH41-4AM	
1	RATED VOLTAGE	V	5,7	2,8	1,9	2
2	CURRENT/PHASE	A	1	2	3	2,8
3	RESISTANCE/PHASE	Ω	5,7	1,4	0,63	0,7
4	INDUCTANCE/PHASE	mH	8	2,2	1	2,2
5	HOLDING TORQUE	NM	0,39	0,39	0,39	0,55
6	ROTOR INERTIA	G-CM ²	120	120	120	120
7	WEIGHT	KG	0,45	0,45	0,45	0,45
8	NUMBER OF LEADS	N°	6	6	6	4

Speed vs. Torque Characteristics

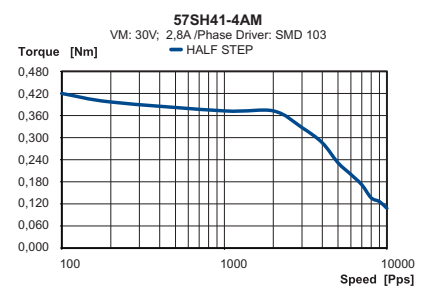
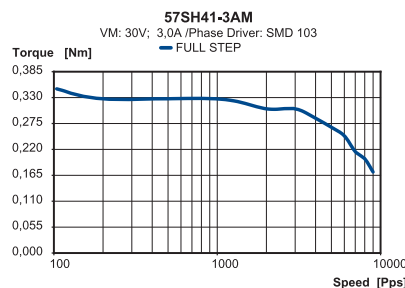
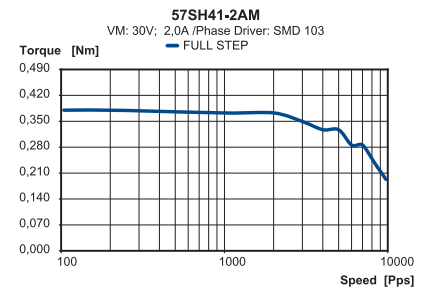
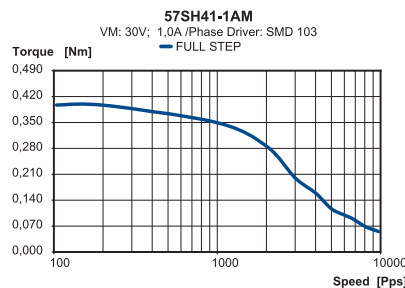

Connection

LEAD N°	COLOR	GAUGE	FUNCTION
1	BLACK	UL1430 AWG22	PHASE A
2	GREEN	UL1430 AWG22	PHASE A-
3	RED	UL1430 AWG22	PHASE B
4	BLUE	UL1430 AWG22	PHASE B-
UNIPOLAR MOTOR			
5	YELLOW	UL1430 AWG22	COM PHASE A
6	WHITE	UL1430 AWG22	COM PHASE B

